

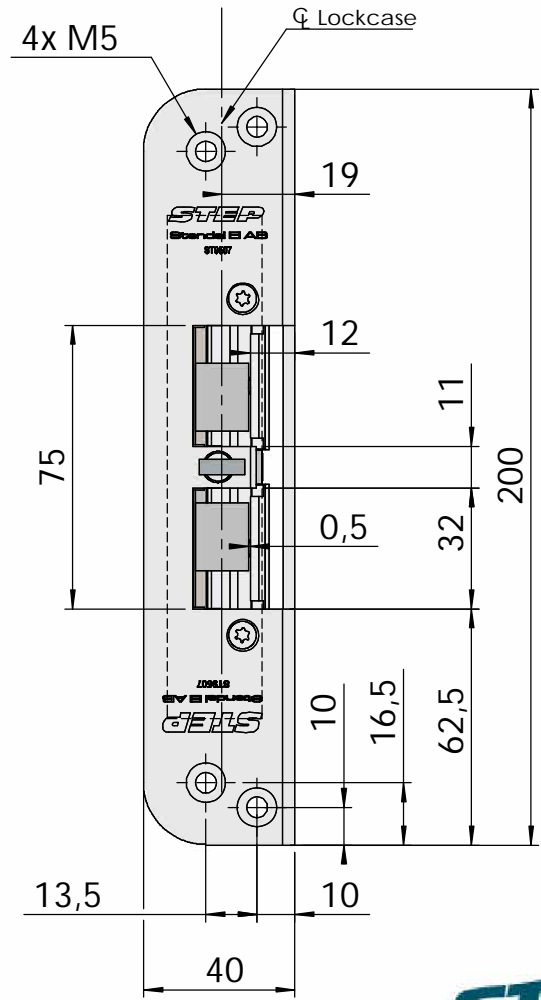

Montering för Modul

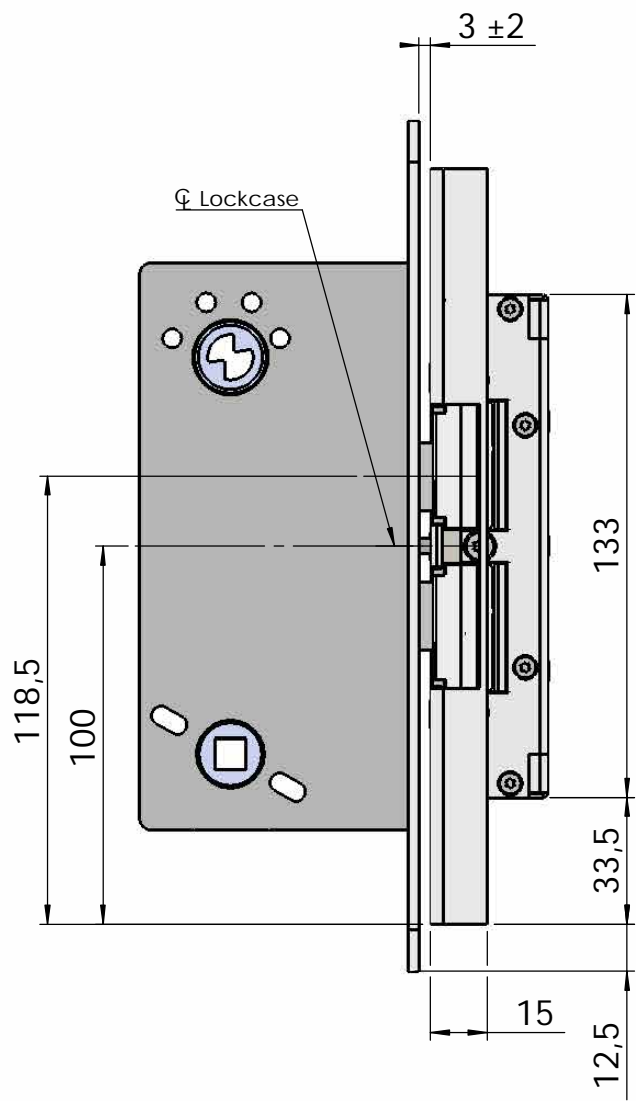
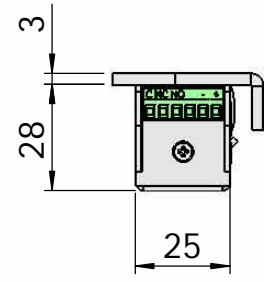

This document shall not be copied without owners written allowance and its content shall not be exposed for third part nor be used for unauthorized purpose.

Owner
Stendals EI AB

Title/Description
**STEP 92 med vinklad stolpe plös 12mm
Montering för Modul**

Drawing no. **ST9507**

Scale
1:2